

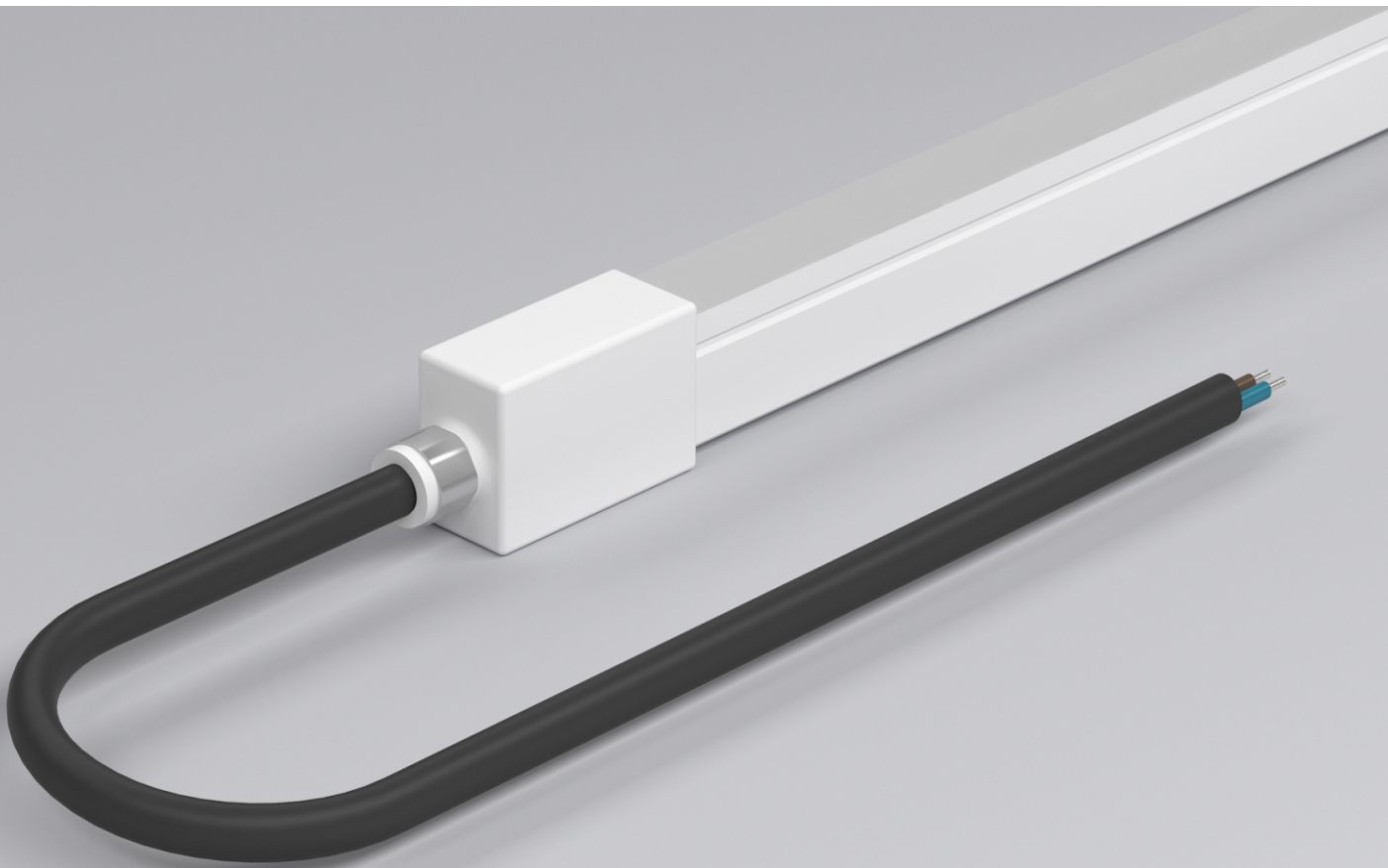

LED NEON FLEX SPECIFICATION

IP68 NEON MON1220 24V SIDE VIEW



Made of Dow Chemical SILASTIC™ ET-7021 silicone, higher transparency and strength

Integrated extrusion process, constant current IC design, 15m for one end power feed

IP68 protection level, Chlorination resistant, can be used in swimming pool

3 years warranty, working life ≥ 30000 hours

2400K 2600K 3000K 4000K 6000K 2600K 6000K

R G B Y O P RGE SPI



Dimension structure

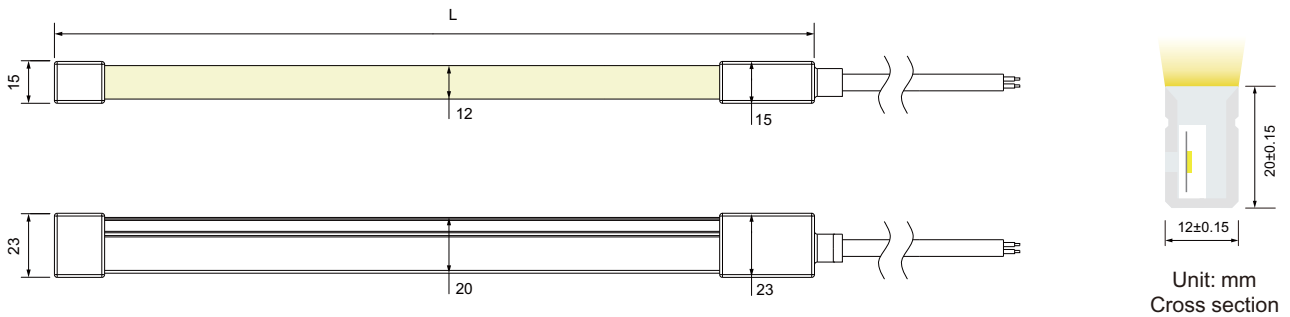

Product specification

Voltage	DC24 V
CRI/Ra	>90
Ambient temperature	-25°C~45°C

Length Range(m)	Final Length(mm)		Tolerance (mm)
	Start from one end only	Start from both ends	
0m<Length≤5m	L+19	L+30	±9
5m<Length≤10m	L+19	L+30	±13
10≤L≤15	L+19	L+30	±15

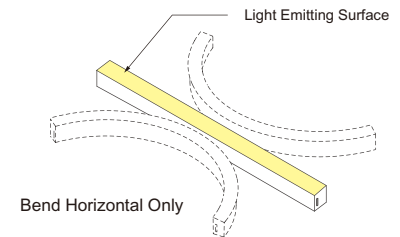
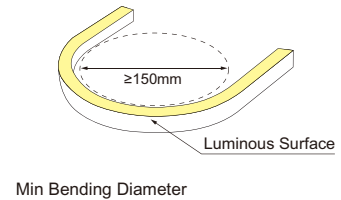

White color parameters

Part Number	CCT (K)	Power (w/m)	Efficiency (lm/w)	Lumen (lm/m)	Unit Length (mm)	Max Run Length (m)
NS-MON1220-W24	2250-2550K	10	29.0	290.0	50	15
NS-MON1220-W26	2450-2750K	10	24.2	242.0	50	15
NS-MON1220-W30	2850-3150K	10	28.5	285.0	50	15
NS-MON1220-W40	3700-4300K	10	27.2	272.0	50	15
NS-MON1220-W60	5600-6400K	10	28.1	281.0	50	15

Single color parameters

Part Number	Color (nm)	Power (w/m)	Efficiency (lm/w)	Lumen (lm/m)	Unit Length (mm)	Max Run Length (m)
NS-MON1220-R	Red(620-625nm)	10	13.9	139.0	50	15
NS-MON1220-G	Green(515-525nm)	10	27.5	275.0	50	15
NS-MON1220-B	Blue(460-465nm)	10	5.4	53.5	50	15
NS-MON1220-Y	Yellow(585-595nm)	10	11.3	113.0	50	15
NS-MON1220-O	Orange	10	12.2	122.0	50	15
NS-MON1220-P	Pink	10	24.2	242.0	50	15

Tunable color parameters

Part Number	CCT (K)	Power (w/m)	Efficiency (lm/w)	Lumen (lm/m)	Unit Length (mm)	Max Run Length (m)
NS-MON1220-TW	2450-2750K	5	28.0	140.0	62.5	5
NS-MON1220-TW	5600-6400K	5	29.0	145.0	62.5	5
NS-MON1220-TW	3600-4200K	10	28.5	285.0	62.5	5

RGB color parameters

CCT (k)	CRI	Power (w/m)	Efficiency (lm/w)	Lumen (lm/m)	Unit Length (mm)	Max Run Length (m)
R	-	3.3	11.0	36.3	83.33	5
G	-	3.3	39.3	129.7	83.33	5
B	-	3.3	7.4	24.4	83.33	5
RGB	-	10	19.0	190.0	83.33	5

Digital RGB

Voltage (v)	CCT (k)	Power (w/m)	Efficiency (lm/w)	Lumen (lm/m)	Pixel (PCS)	Signal Type	IC Model	Unit Length (mm)
24	R	4.8	10.6	50.9	8	SPI	UCS1903	125
24	G	4.8	26.3	126.2	8	SPI	UCS1903	125
24	B	4.8	4.7	22.6	8	SPI	UCS1903	125
24	RGB	11.5	17.4	200.1	8	SPI	UCS1903	125

Cable specification

Cable Type	Schematic Diagram	Specification	Core	Electrical Properties
		OD : 6.3mm		Brown V+, Blue V-
Rubber Cables		OD : 6.8mm		Dual-White: Brown V+, White W, Yellow WW
		OD : 6.8mm		Digital RGB: Brown V+, Blue V-, Yellow-Green DI/DO
		OD : 7.5mm		BrownV+, Blue B, Yellow-Green G, Black R

⚠ Do not immerse the power cable connection in water. Otherwise, there is a risk of short circuit !

Mounting Way

Mounting Clips

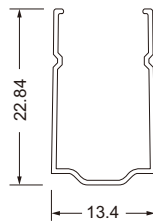

Dimension:
20x13.4x22.84mm
Accessories:
Screw M3x15mm

Aluminium Profile

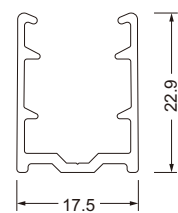

Dimension:
1000(±5)x17.5x22.9mm
Accessories:
Screw M3x15mm

⚠ Aluminum profiles cannot be used in swimming pools.

Connection Diagram

Single Color NEON

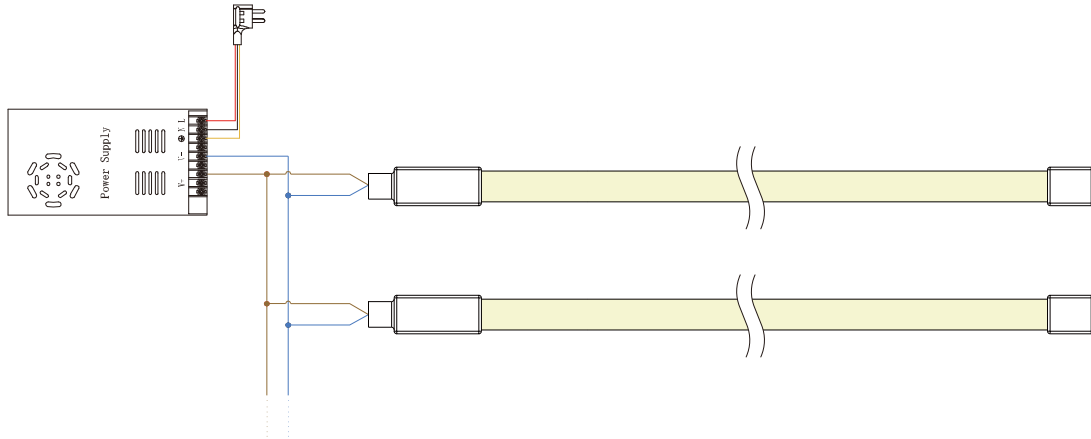

Tunable White NEON

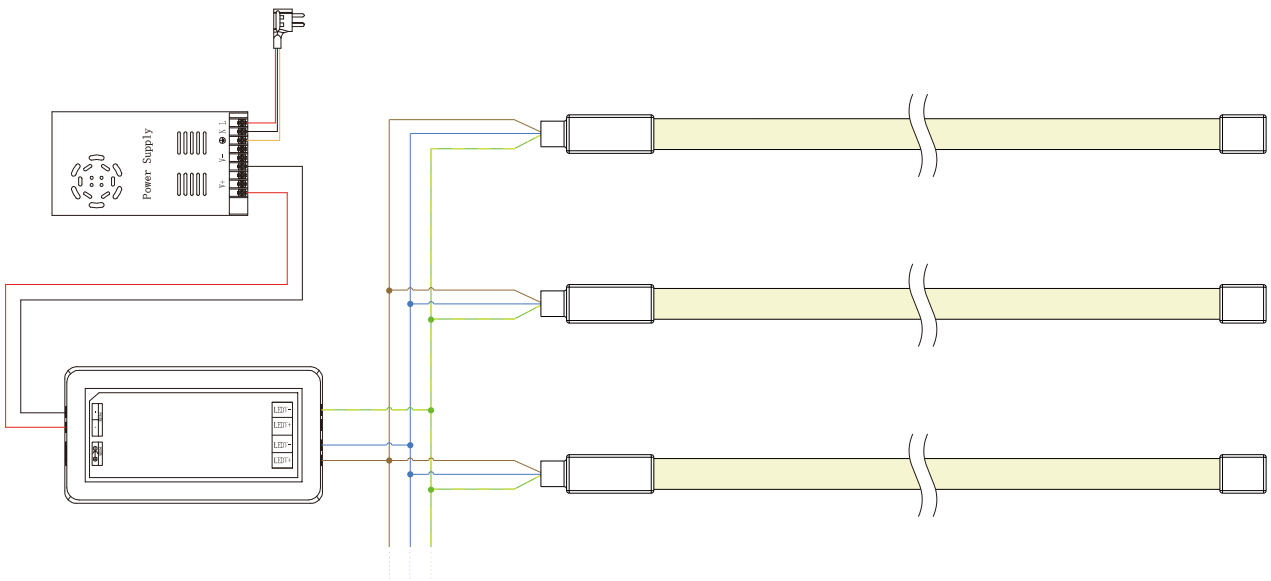

RGB Connection Diagram

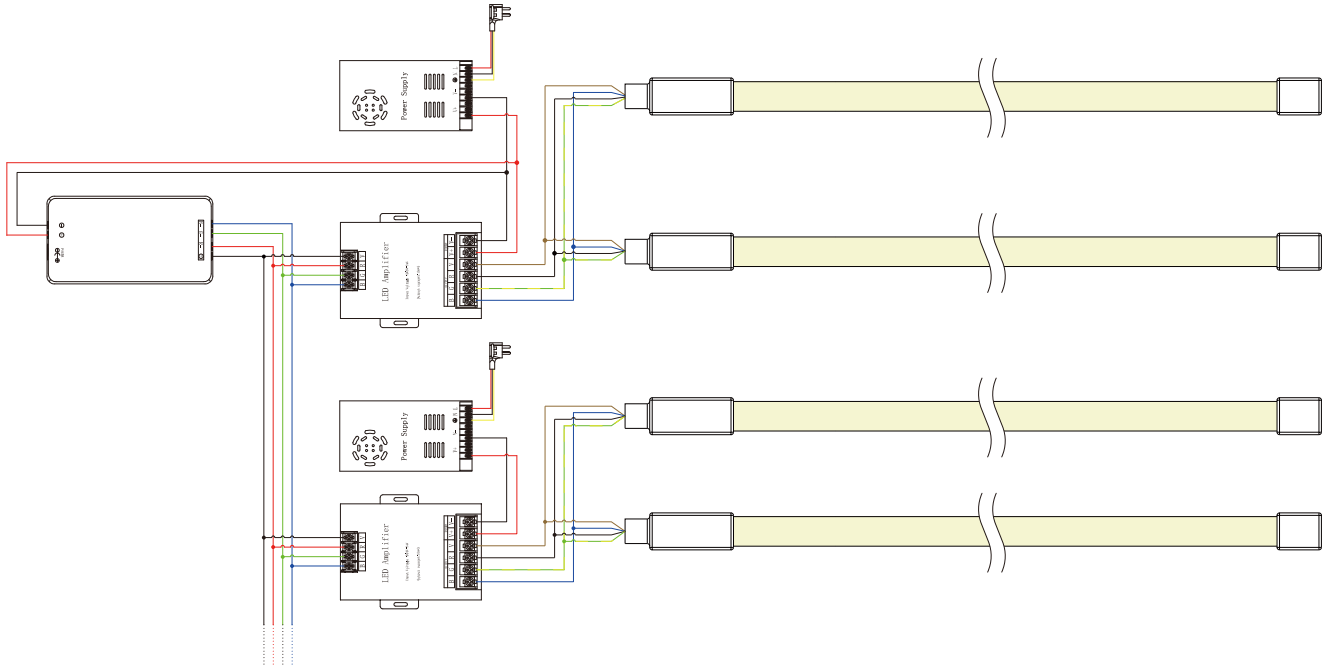

Installation Precautions

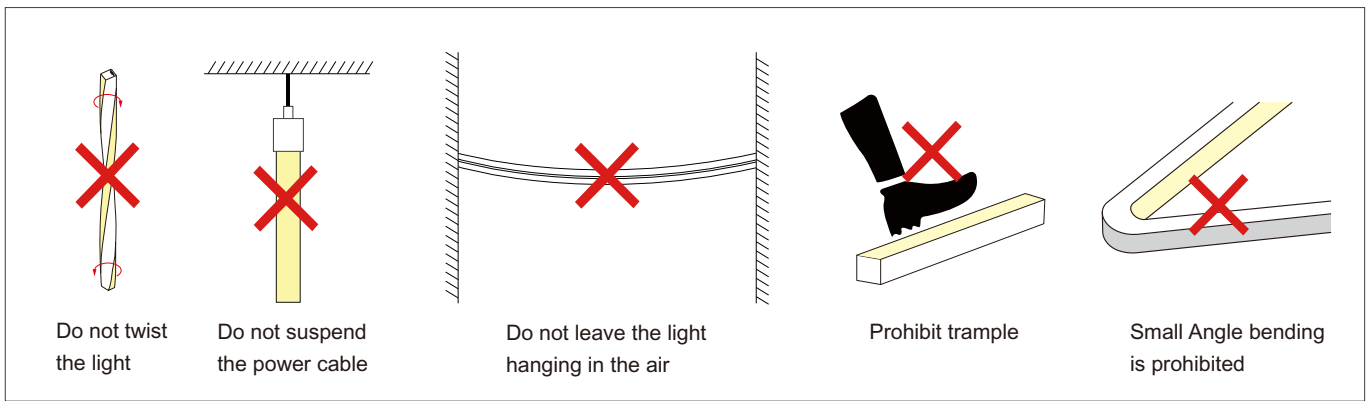
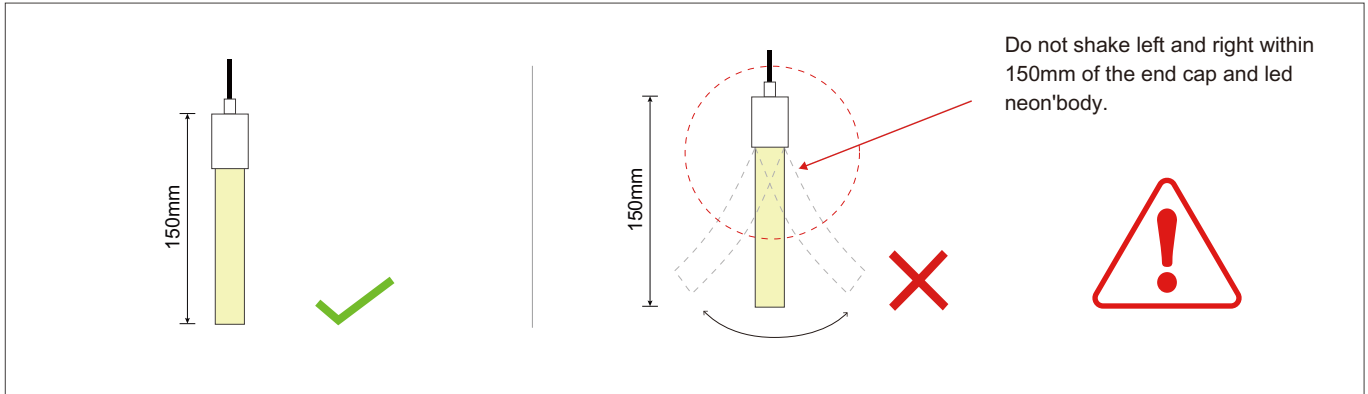

Put it in the profile

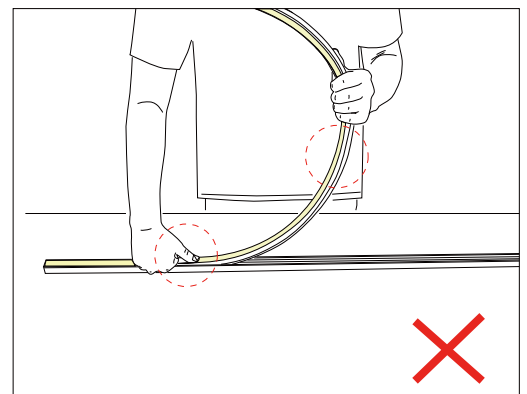
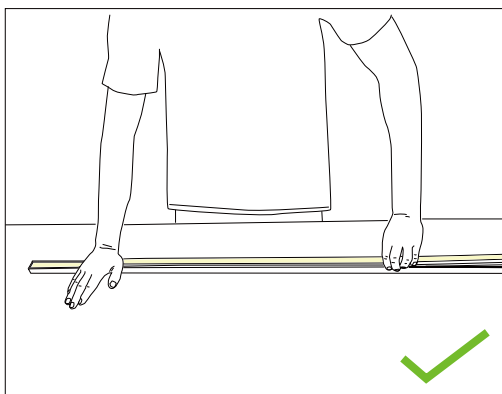

- Please press the led strip with your palm to slowly insert the led strip into the groove, and gently straighten the led strip above the groove with your right hand.
- Try to keep the led strip in a flat state during the installation process.

- Do not press the led strip with a single finger, it is easy to damage the internal parts of the led strip.
- The bent arc of the led strip should not be too large during installation.

Installation Precautions -- Side Mounted (If the length of the light is more than 2 meters, two persons must work together to install it.)

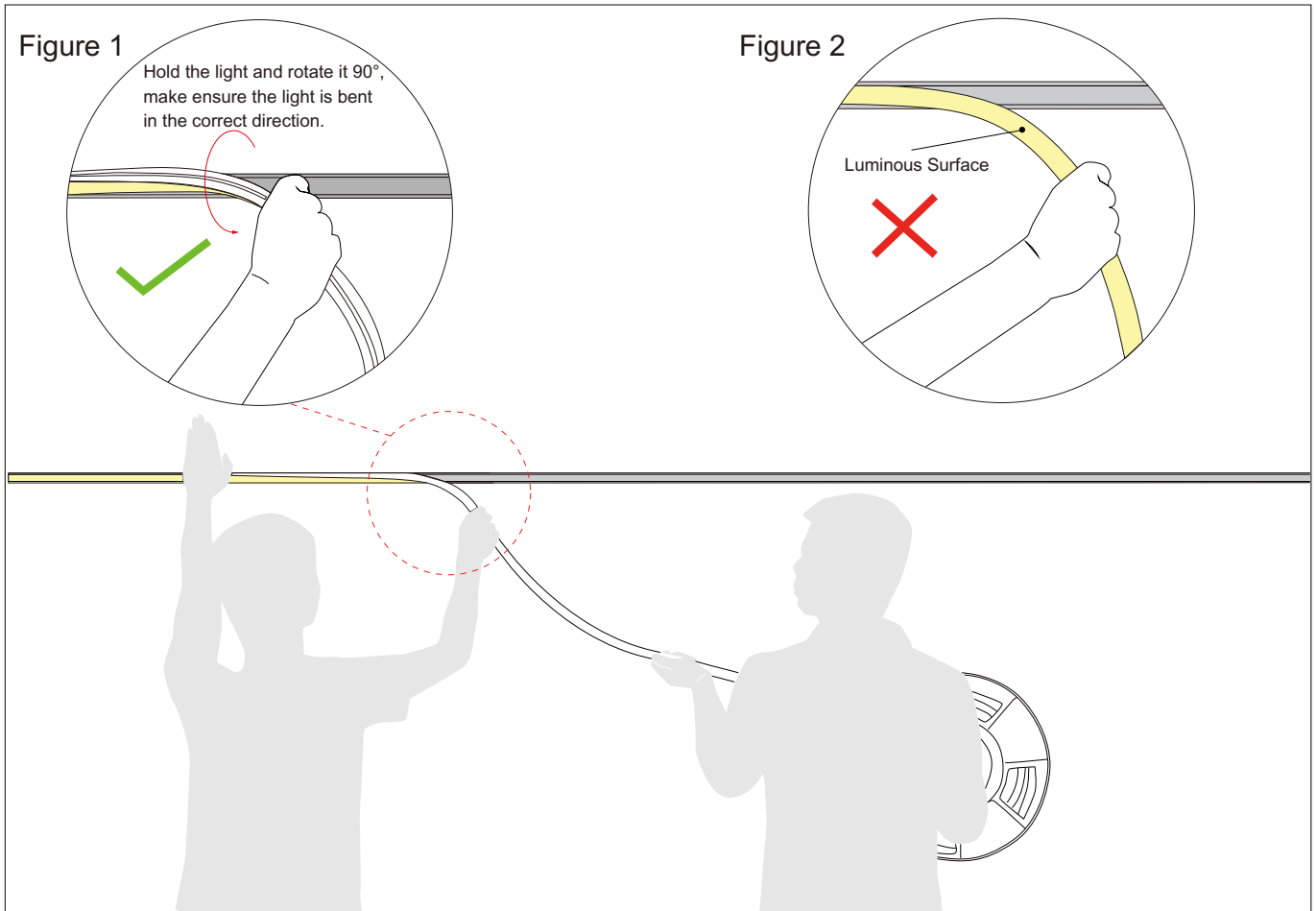

1. Installer:

- Press the light with the palm of the left hand to slowly load it into the slot. Straighten the light with right hand, hold it and rotate it 90° to droop it in the direction of your hand. See Figure 1.
- Do not bend the luminous surface to the side. See Figure 2.

2. Assistant:

- Cooperate with the installer to lift the reel of the light, and then slowly deliver the light to installer. Do not pull or twist the light during the installation.

Installation Precautions -- Side Mounted (If the length of the light is more than 5 meters, two persons must work together to install it.)

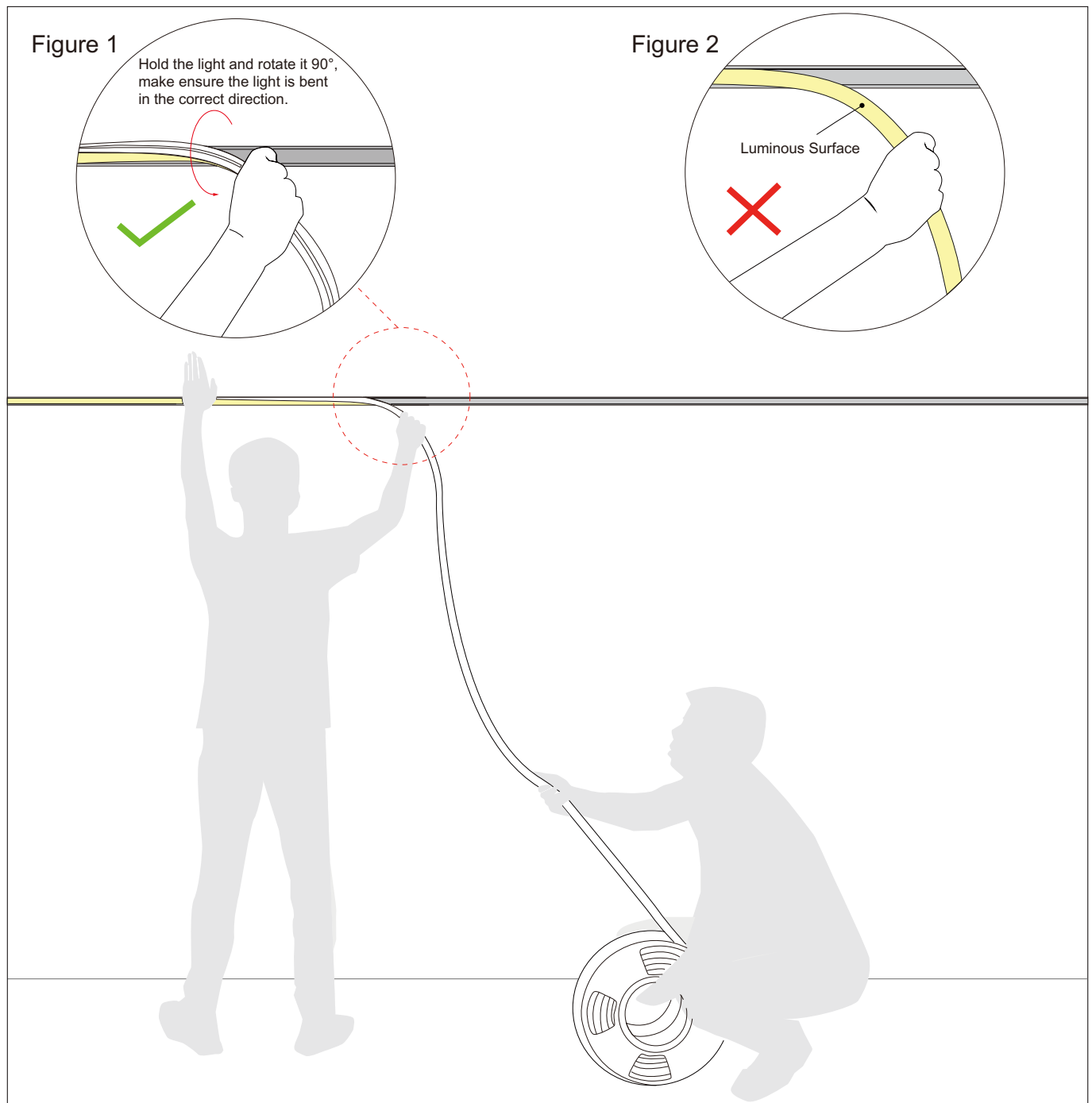

Figure 1

Hold the light and rotate it 90°, make ensure the light is bent in the correct direction.

Figure 2

Luminous Surface

1. Installer:

- Press the light with the palm of the left hand to slowly load it into the slot. Straighten the light with right hand, hold it and rotate it 90° to droop it in the direction of your hand. See Figure 1.
- Do not bend the luminous surface to the side. See Figure 2.

2. Assistant:

- Cooperate with the installer to slowly deliver the light to installer. Do not pull or twist the light during the installation.

Notes

The selection of the cable specification at the output end of the power supply, it depends on the total current of the load and the length of the cable. It is recommended to select according to the following table:

Current of the light	Specifications of the cable								
	L=1M	L=2M	L=4M	L=6M	L=8M	L=10M	L=12M	L=14M	L=16M
1A	AWG26	AWG23	AWG21	AWG18	AWG18	AWG17	AWG16	AWG15	AWG15
2A	AWG23	AWG21	AWG18	AWG16	AWG15	AWG14	AWG13	AWG12	AWG12
3A	AWG22	AWG18	AWG16	AWG14	AWG13	AWG12	AWG11	AWG11	AWG10
4A	AWG21	AWG18	AWG15	AWG13	AWG12	AWG11	AWG10	AWG9	AWG9
5A	AWG20	AWG17	AWG14	AWG12	AWG11	AWG10	AWG9	AWG9	AWG8
6A	AWG18	AWG16	AWG13	AWG11	AWG10	AWG9	AWG8	AWG8	AWG7
7A	AWG18	AWG15	AWG12	AWG11	AWG9	AWG8	AWG8	AWG7	AWG6
8A	AWG17	AWG15	AWG12	AWG10	AWG9	AWG8	AWG7	AWG7	AWG6
9A	AWG17	AWG14	AWG11	AWG10	AWG8	AWG7	AWG7	AWG6	AWG5
10A	AWG16	AWG14	AWG11	AWG9	AWG8	AWG7	AWG6	AWG6	AWG5

- ※ The unused light should be sealed with the packaging bag to avoid prolonged exposure.
- ※ Please use DC24V isolated constant voltage power supply with ripple voltage less than 5%. Using other types of power supply may damage the light or cause other safety risks.
- ※ In practical application, 20% allowance should be reserved for power supply to ensure the stability of power supply.
- ※ It is recommended that professionals connect the power supply. Do not connect the power supply with live power to avoid electric shock.
- ※ Please confirm whether the voltage of the power supply is consistent with the voltage of the light; Pay attention to the positive and negative poles of the power cord, do not connect wrong, so as not to cause product damage:
- ※ When multiple power supplies are used, ensure that the positive poles of the power supply are not connected in parallel. Otherwise, the power supply system may be unstable or damaged after long-term operation.
- ※ If the actual application length exceeds the specified length, it will lead to overload, heating and uneven brightness of the light.
- ※ During installation, please do not scratch, twist, or bend the light irregularly. Otherwise, the light may be damaged beyond repair.
- ※ To ensure the life and reliability of the light, please do not over bend the light, which will damage the product itself.
- ※ To protect your eyes, please avoid staring at the glowing surface of the light for a long time.
- ※ Non-professionals are forbidden to install, disassemble and maintain the product.
- ※ Do not use any acid or alkaline adhesive to fix the light (including but not limited to glass glue, etc.)
- ※ Because of the difference in structure, even if the same color temperature value, different sizes of light will look slightly different colors. Please confirm it before use.

Tests showed that methanol and benzenes will have yellowing effects on silicone.

In the newly decorated interior environment, epoxy floor paint, wall paint, wallpaper adhesive, various decoration materials or new furniture, they are likely to release of methanol and benzenes.

It is recommended to remove methanol and benzenes first, or ventilate for a period of time in the newly decorated interior environment before install the silicone neon light, to avoid affecting the silicone body.